

PS65 PS105

Versatile Vertical Machining Center



HARMONY WITHIN POWER, ACCURACY AND SPEED WITH SUSTAINED RELIABILITY

Makino's PS Series Vertical Machining Centre, targeting the high mix and low volume segment of the manufacturing sector, provides users the capability to meet the requirements for precision metal cutting industries like Aerospace, Medical, Automotive, General Engineering and Precision Engineering.

Equipped with Makino's high performance spindle technology, the PS Series guarantees optimal material removal rates with desired surface finish and accuracy. The mechanical structure with linear guideway design ensures swift, stable, rigid and precise motion even with the heaviest of loads installed.

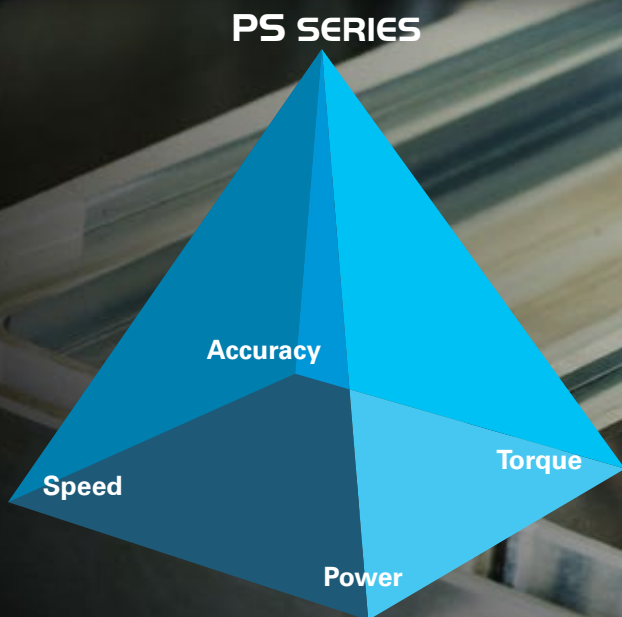

POWERFUL STRUCTURE

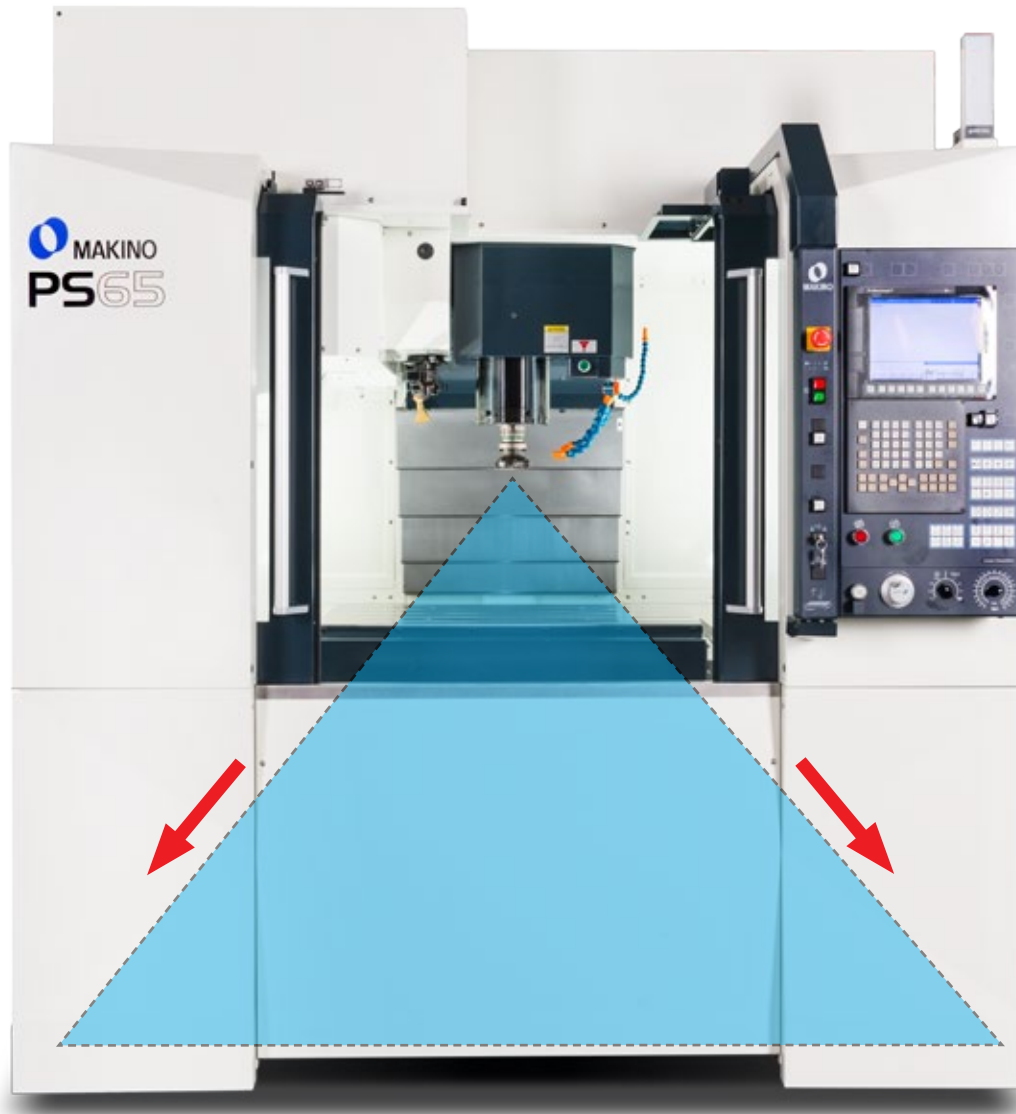

A pyramid is the most stable geometric structure. It is sturdy, stiff and rigid. It derives its natural strength from each of the three sides which support the other two against lateral pressures. The pyramid will not change shape, bend, buckle, twist, warp or deform.

Likewise, the PS Series machine is designed from the ground up to provide outstanding stiffness, rigidity, thermal stability, speed, power and accuracy to tackle even the toughest production part materials and tolerances. The C-frame structure ensures the quick, efficient transfer of the cutting forces through the various elements of the machine from spindle into the column and ultimately the bed of the machine.

Finite Element Analysis (FEA) design techniques were employed to perfect the massive cast bed, column, saddle, carrier and table components which provide optimal rigidity and torsional stiffness for ultimate performance characteristics and consistent results. The C-frame configuration provides the most effective utilization of machine mass offering the largest workzone without increasing the footprint size. The design produces an Agile machine with faster, quicker movements leading to the highest level of productivity.

PRODUCTIVE SPINDLE

Makino's leadership in spindle technology is renowned throughout the world. Spindle rigidity, higher RPM, constant pre-load, multi-plane balancing, minimizing vibration and controlling thermal growth are all issues that Makino has solved through years of experience and application of spindle design, manufacture, and assembly.



PS Series standard 8,000 rpm spindle and optional 14,000 rpm spindle offers the ideal blend of speed, power and torque. Both spindles are equipped with 30kW Power & 175Nm Torque that offers efficient, highly productive machining characteristics to address a wide range of materials typical of the production environment. The two-range, cartridge design spindle provides stiffness and rigidity at the lower ranges for roughing operations in tough materials yet, offers the vibration and chatter-free, high spindle speed cutting capability needed to be productive in aluminum applications. Optional 14,000 rpm spindle is equipped with oil air lubrication to have good thermal stability for high speed RPM application.

The incorporation of a large capacity, heat dissipating spindle chiller (or Oilmatic Unit) closed – loop linked with a thermocouple monitors the machine bed temperature and maintains the thermal stability of the entire system. Controlled oil is circulated in a jacket surrounding the spindle and then routed through the ballscrew support bearings and center of the ballscrews, creating an “on machine” ambient manufacturing zone that minimizes the thermal impact and provides process consistency.

As an optional configuration, the PS Series, standard 8,000 rpm & optional 14,000 rpm spindle, can be configured with an HSK-A63 spindle interfacet.

HSK spindle (Option)

The HSK shank system with two restrained faces simultaneously couples the taper portion of the shank and the flange end face.



HSK-A63 holder

1. Improved Heavy-Duty Cutting Performance

The difference in cutting performance is especially noticeable when machining with longer shank tools.

2. Improved Accuracy

Excellent attachment accuracy is faithfully reproduced for greater machining accuracy. This system firmly secures the tool holder both on face and the shank and provides very high rigidity and improved accuracy. Strongly recommended for high-speed applications.

UNBEATABLE PERFORMANCE

While the power and cutter technology helps to achieve higher MRR, the quality of the machined surface depends on the stiffness of the spindle. Designed with large bearing of 85mm (similar to 50 taper class) the spindle remains very stable during forward and reverse motion giving a surface which is truly flat. In traditional machines, the spindle deflects at the engagement and exiting the material resulting in an uneven surface. This is well known as the pendulum effect.



Face mill	Ø80	Ø63
Material Removal Rate	800 cm ³ /min	3,750 cm ³ /min
Depth/Width of Cut	5.7 / 60mm	7.5 / 50mm
Material	S45C	A5052
Spindle Speed	1,300 rpm	10,000 rpm
Feedrate	2,340 mm/min	10,000 mm/min



63 mm dia. Drill
Material Removal Rate 467 cm³/min
Spindle Speed 1,200 rpm
Feedrate 150 mm/min
Depth of Cut 40 mm
Material S45C

STANDARD 8,000 RPM SPINDLE

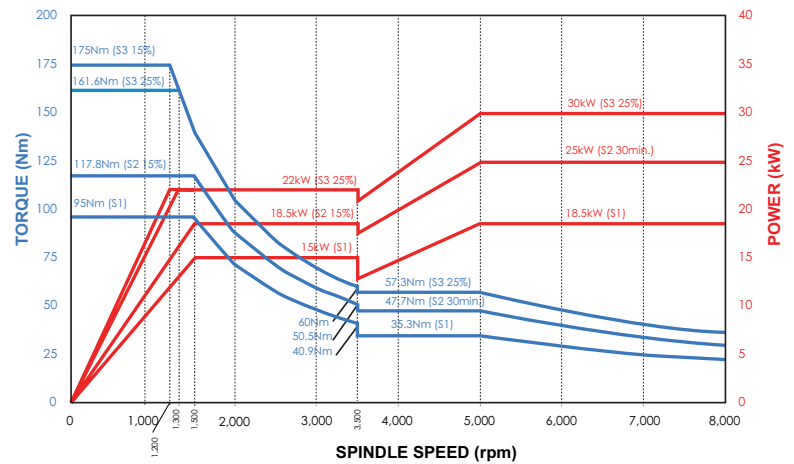

OPTIONAL 14,000 RPM SPINDLE

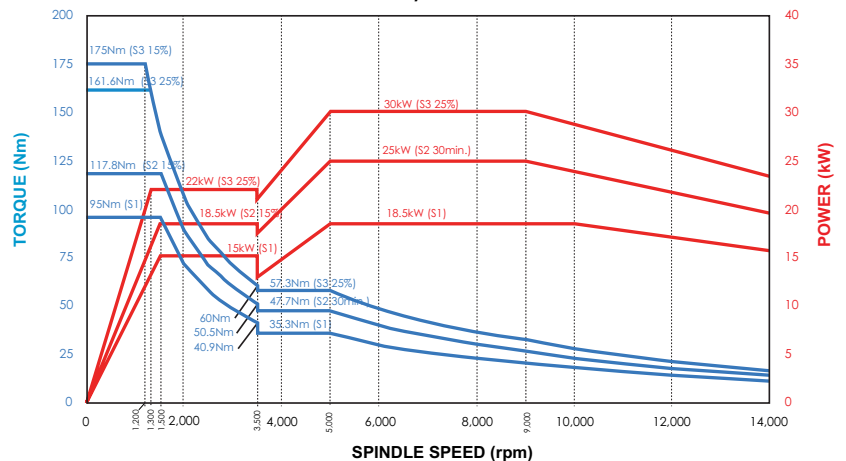

PROCESS STABILITY

Apart from the spindle technology which accounts for the High Material Removal Rate (MRR), Makino also adopted the core cooling of ball screw to achieve thermal balance which is an important factor to deliver accuracy. There are 15 axis bearings which support the axis and are traditionally grease packed bearings. During the axis motion, the ball screw rotates in both forward and reverse direction. Quick change of rotation of the ball screw generates heat and knocking effect, thereby leading to poor axis control. The PS Series delivers thermal controlled lubrication oil through the ball screw and support bearing to enhance the life and sustains accuracy.

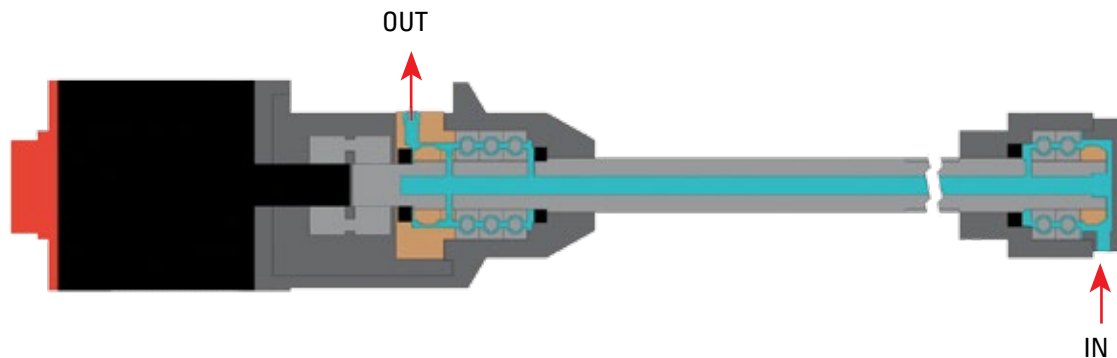
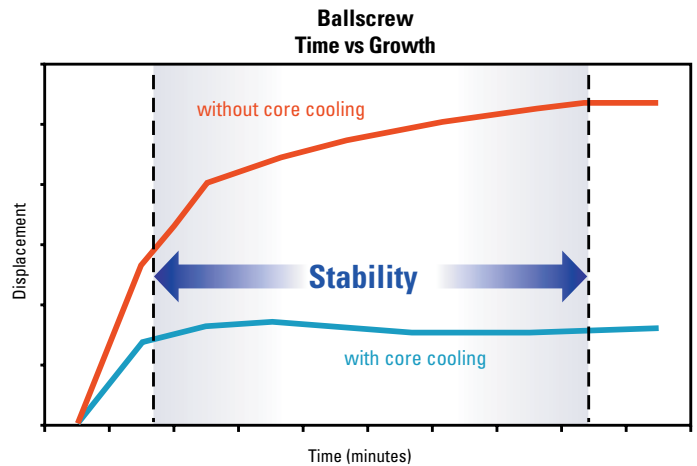

Temperature controlled oil is circulated through the ballscrew support bearings and the center of the ballscrews. This process manages and reduces thermal growth, significantly shortens the thermal saturation time, virtually eliminating "warm-ups"; maintains a lower system operating temperature, controls thermal drift and enhances accuracy. Combined with the cooled ball screws and support bearings and a closed-loop temperature compensation system, the symmetrical nature of the casting secures the tightest tolerance and minimal variations during long production part runs.

Together with absolute million pulse per revolution Fanuc servo motors, the machine design features reduce variability for hours of continuous, tight tolerance machining, providing the PS Series machines with outstanding production tolerance performance.

To ensure highest functionality and productivity, with minimal operator intervention and associated downtime, the PS Series machines are equipped with an automatic lubrication system for the guideway and ballscrew systems.

PERSONNEL SPACE



Easy Spindle accessibility for tool loading at spindle side



Easy ATC magazine accessibility for tool loading at magazine side

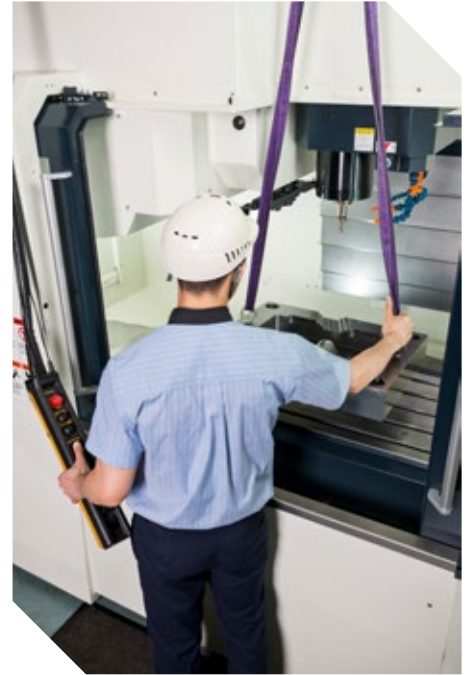

The machine ceiling opens, to facilitate easy handling of large, heavy workpieces and fixtures that require an overhead crane



Easy operation with good hand eye co-ordination aided by 90° swing of operation panel

Professional P



The PS Series features Makino's Professional P control software configured to support a wide variety of applications in the job-shop and production environment. With a large color LCD, menu driven, touch sensitive screen, information is only a "touch" away. Configured with generous program storage (1,280m), 400 registerable programs, 400 tool-offset pairs and 48 pairs of work coordinate systems, the Professional P provides ample standard capabilities for production shops of all sizes.

PRODUCTION SUPPORT

Created with the production environment in mind, the PS Series chip and coolant management systems enhance the productivity of the machine. Configured with nozzle and flush coolant as standard features, chips are efficiently and effectively removed from the cutting zone. Spiral chip conveyors located on the left and right side of the work table quickly and efficiently evacuate chips and coolant from the machining zone. With LUCC option integrated, the machine is tailored for efficient chip handling to the specific need of the application.



*Picture of PS105 with two spiral conveyors on each side
*PS65 comes with one spiral conveyor on each side

Coolant Management System

- Large area of opening for chip flow into screw conveyor
- Steep slopes on the sides to avoid chip accumulation
- Coolant flush on the Tele-cover for better evacuation of chips

Lift Up Chip Conveyor Scrapper Drum (option)

To complement and increase the productivity further in evacuating chips effectively, Lift Up Chip Conveyor (LUCC) scrapper drum is available with PS Series as an optional equipment to accomplish the following benefits:

- Separates the chips and cutting fluid discharged by the screw conveyor
- Discharges cutting chips from the machine
- Returns cutting fluid to the dirty tank
- The cutting fluid in the dirty tank is then filtered through the drum unit filter and transferred to the clean tank

Filters are mounted around the drum unit. Chips caught in the filters are removed by cutting fluid, flushed from the filter cleaning nozzles located inside the drum unit.



LUCC Scrapper Drum type (Option)

Oil Skimmer (Option)

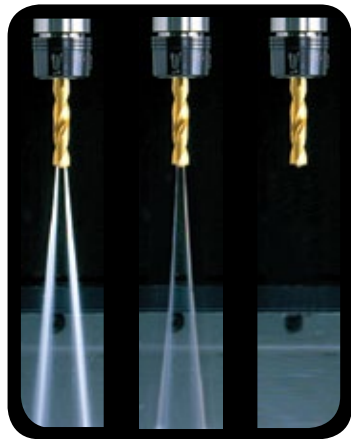

FAST SUCTION

Through Spindle Coolant (option)

This feature improves the machining process during deep hole drilling operations and at the same time, increases the tool life.

In Makino's system, the coolant recovery feature utilizes a coolant suction mechanism instead of the traditional way of purging. This feature does not increase ATC time and prevents leakage of coolant during tool change.

Coolant Nozzles (standard)

PS Series has 8 built-in nozzle outlets and 2 flexible nozzle hoses for chips flushing which results in increased tool life and improved machining performance.

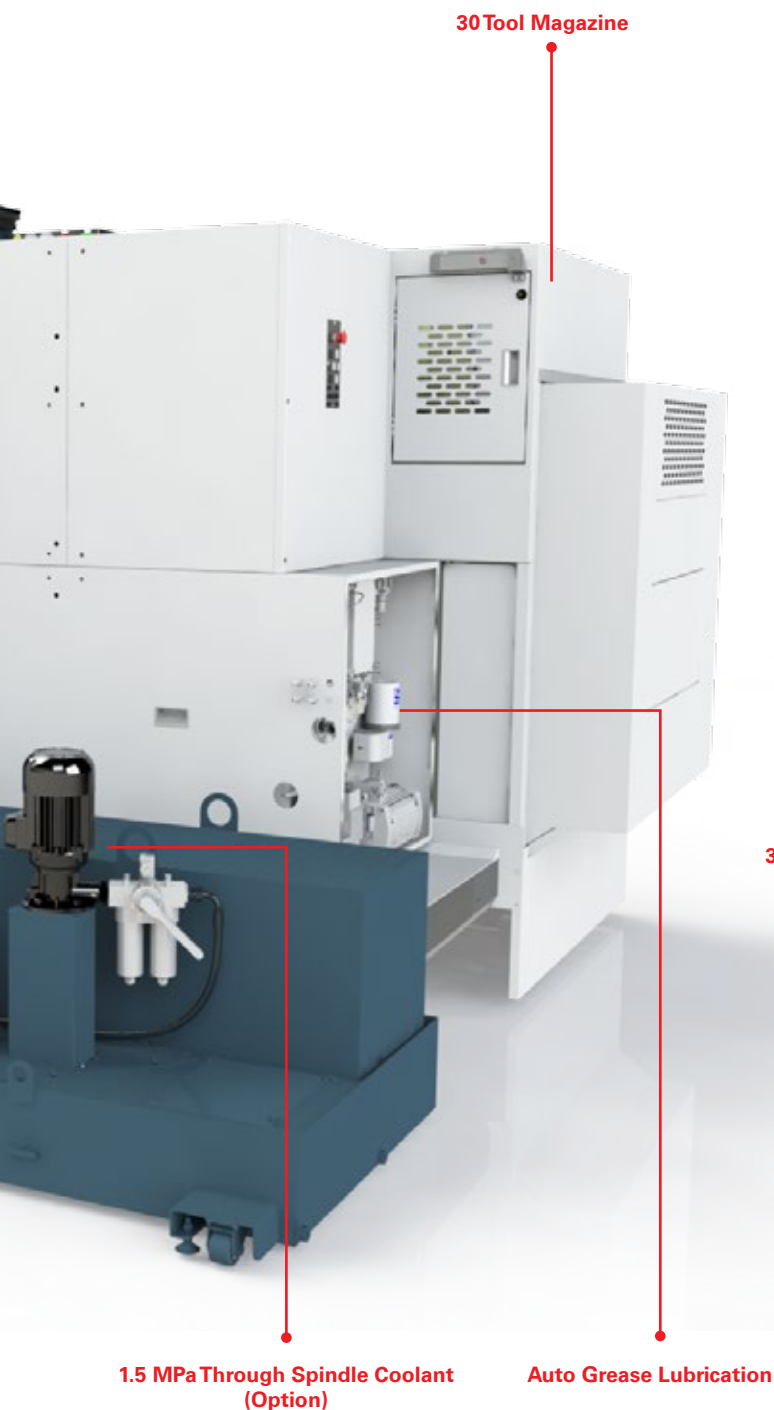

30 Tool Magazine

1.5 MPa Through Spindle Coolant (Option)

Auto Grease Lubrication

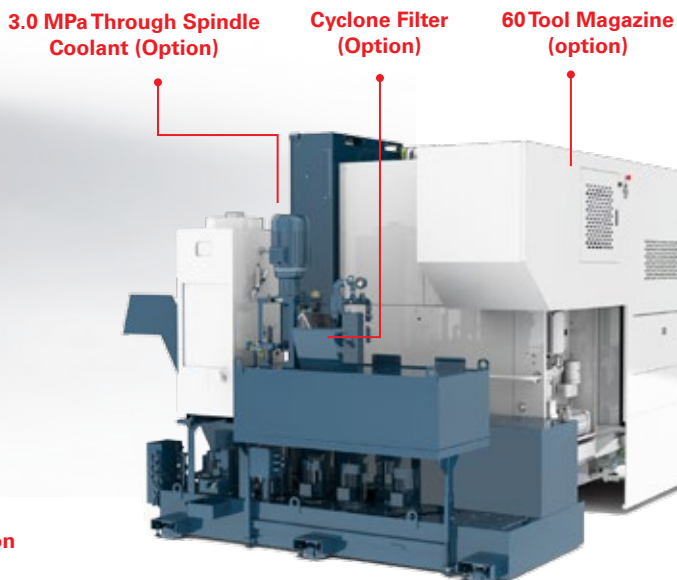

3.0 MPa Through Spindle Coolant (Option)

Cyclone Filter (Option)

60 Tool Magazine (option)

AUTOMATION READY

Interface for Hydraulic Fixture / Rotary Work Head

Interface for hydraulic fixtures (option) can be done from the ports on table. The maximum number of ports available are 6 hydraulic, 8 pneumatic and 1 coolant.



Hydraulic Fixture Control

Software interface for Hydraulic Fixture Control through touch screen operations, sequences like work load / unload and fixture clamp / unclamp can be easily customized. The sequence logic for work loading and work unloading can be modified easily in Professional P (only by supervisor user).

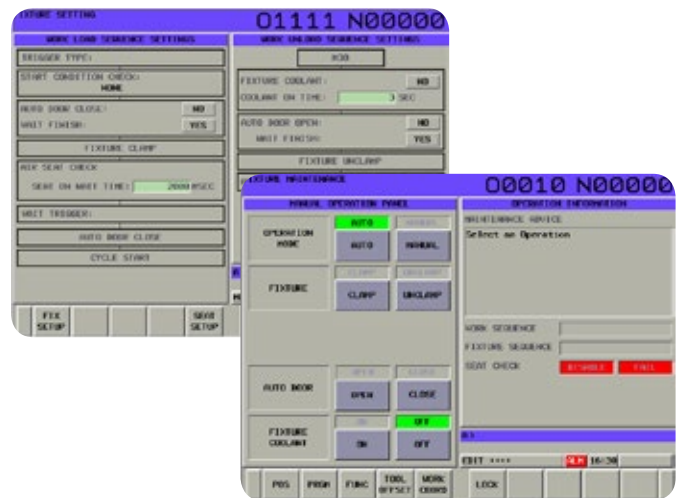

Robot Interface

With the increase in demand for automation in the global market, automating production processes to optimise the use of time, materials, human resources, maintain the highest possible quality standards and reduction of costs is needed. The PS Series is equipped with optional interfaces for it to be ready for automation systems available in the market. These may include 4th axis tables, tool length measurement, spindle probe, light curtain, auto doors and a variety of other features.



ATC Recovery

With one step, recovery is possible without remembering the sequence.





Tool Monitoring

Spindle Load (SL) monitoring

Monitors the spindle load current for each tool. If the spindle current exceeds a preset load value, it issues an alarm and shuts down the machine.

Tool Life (TL) monitoring

Monitors tool life according to preset tool lifetime or cutting length. If the end of tool life is reached during operation, it issues an alarm while allowing machining to continue.



Spare Tool Changing

This function allows a spare tool to be pre-designated for every tool used. If a tool causes an alarm, it is automatically replaced with its spare to allow machining to proceed without interruption.

Screen Display for monitoring

The spindle load current and load current of each servo axis (XYZ) are shown on the screen in easy-to-read data during machining. Operators can easily determine the best machining conditions by checking the displayed current loads.



Maintenance and Inspection functions

Regular maintenance display

The items to be checked during regular maintenance are automatically displayed for inspection daily, weekly, monthly and yearly. This prevents items from being neglected during inspection.

ATC FLEXIBILITY

ATC Dual Speed Tool Change System

Dual speed during ATC arm swing to ensures smooth tool change and optimum time.

The system ensures proper tool clamping during tool change that increases tool life and proper seating in both the spindle and the ATC pots.

Each tool configuration can be customized as to the type of arm speed used during ATC. High speed for tools with less than 6kg weight and low speed for tools with more than 6kg weight. This will increase the productivity of the machine by decreasing non cutting time that is consumed during tool change.

ATC Configuration	
Fixed pot configuration	Pot can be assigned as fixed pot
Heavy Tool configuration tool	> 6kg to be assigned as heavy
Tool Change prohibition	Tool change can be prohibited for a particular tool



Tool Management

With the standard 30 tool ATC magazine, the PS Series provides smooth and fast indexing to support high speed machining application.

An optional ATC60 is available for large capacity which implements a compact system without additional floor space.

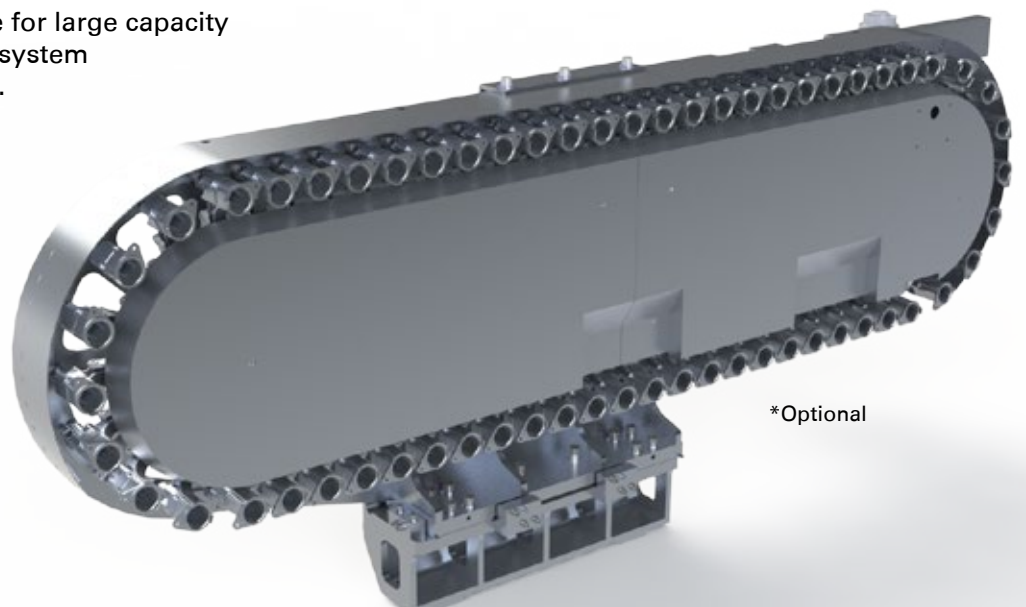

INTELLIGENT TECHNOLOGY

Vision Broken Tool Sensor (Vision BTS)*

The Vision BTS System is located within the tool magazine outside the machining chamber and checks for tool breakage without affecting the cycle time.

The captured geometric tool information is checked against the stored tool data in NC to prevent damages caused by wrong tool loading or wrongly input tool data within an error of 3mm. Minimum tool diameter is 1mm.



Tool breakage illustration



Tool verification against tool length data

Spindle Active-Care (SAC)*

With SAC, unplanned machine downtime can be eliminated by closely monitoring the operational conditions for the spindle and then evolving spindle health status. SAC uses cutting edge signal processing techniques to:

- Detect abnormal spindle impacts / vibration / unbalance and stop the machine to prevent further damages
- Monitor tool unbalance (against maximum value specified by the user) to ensure the required workpiece surface quality
- Analyse the spindle bearing health and eventually warn the operator of any unacceptable health status to allow planned maintenance

In addition, SAC provides software for remote monitoring of machine processes and spindle health status.

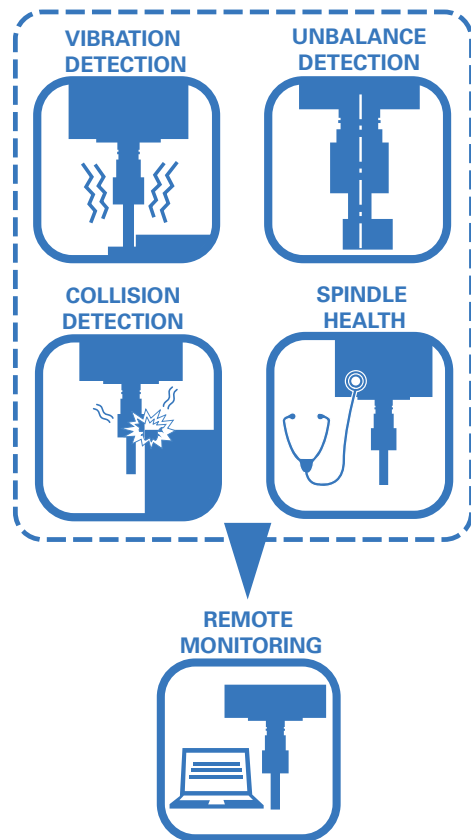

*Optional

PREMIUM SAMPLES

Aerospace



Material: Aluminum (A7071)
Cycle Time: 30 min 41 sec
Tools: 19

Automotive



Material: Aluminum Die Cast (ADC12)
Cycle Time: 2 min 10 sec
Tools: 10

Precision Engineering

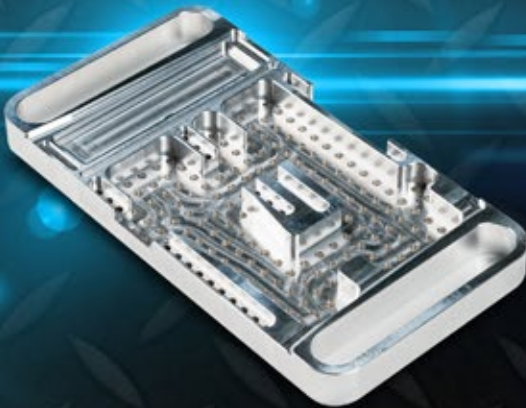

Material: Aluminum (A6061)
Cycle Time: 14 min 17 sec
Tools: 7

General Engineering

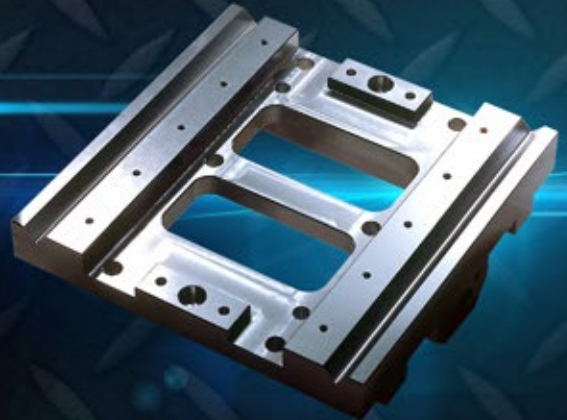

Material: Steel (S45C)
Cycle Time: 39 min
Tools: 11

Mold Base

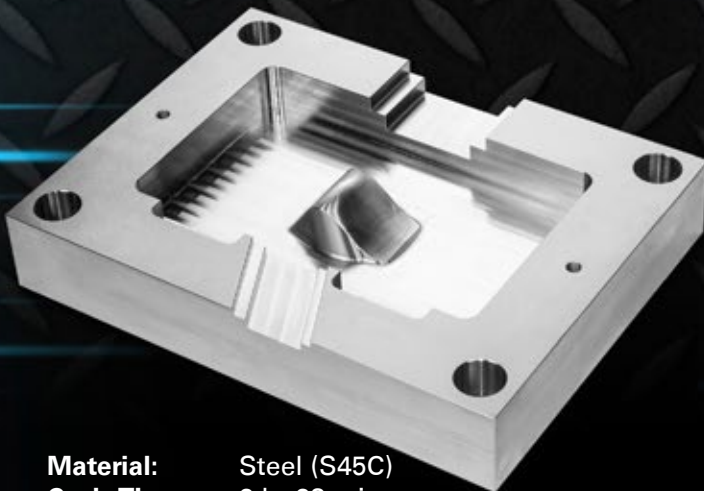

Material: Steel (S45C)
Cycle Time: 3 hr 38 min
Tools: 8

Packaging Mold



Material: Pre-hardened Steel (NAK80)
Cycle Time: 2 hr 13 min 12 sec
Tools: 9

Machine Specification

	Unit	PS65	PS105	
Travels	X	mm	660	1,050
	Y	mm	510	
	Z	mm	460	
	Table Top to Spindle End	mm	150-610	
Table	Size	mm	920 x 510	1,300 x 510
	Payload	kg	600	800
	Work Size (L x W x H)	mm	920 x 510 x 460	1,300 x 510 x 460
	Loading Height	mm	950	
Spindle	Taper	-	#40, HSK-A63*	
	Speed	rpm	50~8,000 / 50 ~14,000*	
	Power (25% ED / cont.)	kW	30 / 18.5	
	Torque (15% ED / cont.)	Nm	175 / 95	
Feedrate	Rapid	mm/min	48,000 (X), 36,000 (Y & Z)	
	Cutting	mm/min	30,000	
ATC	Tool Capacity	-	30 / 60*	
	Tool Diameter / Length	mm/mm	75, 125** / 300	
	Tool Weight	Kg	8	
Power	Electrical Power Supply	V(kVA)	380 - 415 (38)	
Accuracy (Full Stroke)	Positioning wo-scale / w-scale	mm	JIS Standards: ±0.0025, ±0.0015	
	Repeatability wo-scale / w-scale	mm	JIS Standards: ±0.002, ±0.0014	
Machine	Floor Space (L x W)	mm	2,480 x 3,760	2,800 x 3,760
	Height	mm	2,555	
	Weight	kg	7,100	7,300

*Optional
**Alternate pockets empty

Standard Specifications □

- 30-tool ATC
- 50 ~ 8,000 rpm
- Air Blow
- Ball Screw Core Cooling
- Centralized Auto Grease
- Coolant System
- Cooling of Axis Support Bearings
- Custom Macro Variable
- LED Light
- Makino Professional P Control
- Manuals
- Rigid Tapping
- Signal Light 3 Layer
- Spindle Temperature Controller
- Splash Guard Door Lock with ATC interlock
- Y Axis Tele-Cover Washing Coolant

Optional Specification* (●)

- High column (+150 mm)
- 60-tool ATC
- Spindle 50 ~ 14,000 rpm
- HSK-A63
- Scale feedback (X,Y,Z Axis)
- Hydraulic Fixture Control Interface
- 4th Axis NC rotary table Interface
- NC Rotary Table
- Tailstock for NC rotary table
- Splashguard autodoor
- Portable Manual Pulse Generator
- Two-hand push button or striker switch for cycle start
- Lift Up Chip Conveyor (Scraper Drum)
- Coolant temperature control
- Through spindle coolant 1.5 MPa
- Through spindle coolant 1.5 MPa with Cyclone Filter
- Through spindle coolant 3.0 MPa
- Through spindle coolant 3.0 MPa with Cyclone Filter
- ATLM (Automatic tool length measuring device)
- AWM (Automatic workpiece measuring device)
- Power Fail Monitor
- Vision BTS
- Spindle Active-Care
- Data Server (1GB/ 2GB/ 4GB)
- AI Contour Control (AICC2)
- Robot Interface

*Check with Marketing for retrofit possibility

Machine Layout

PS65 • PS105

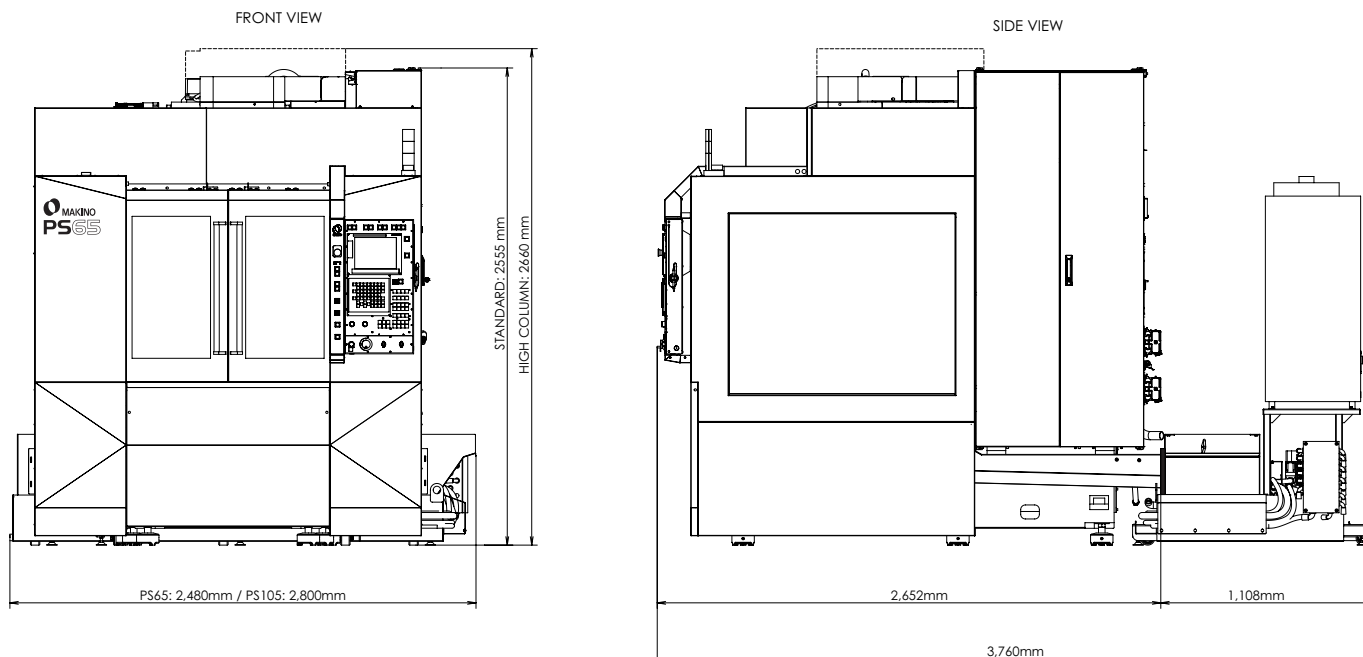



<http://www.makino.com.sg>

*The specifications in this catalog may be changed without prior notice to incorporate improvements resulting from ongoing R&D programs.
*The machines displayed in this catalog are fitted with optional equipment.
*The accuracy and output of machine may vary according to conditions of working environment.
*This product, including technical data and software, may be subjected to the Singapore Foreign Exchange and Foreign Trade Law.
* Prior to any re-sale or re-export of controlled items, please contact Makino to obtain any required authorization or approval.